

SHIPPING CONTENTS:

- Futpong® net (parts and assembly described below)
- Carrying bag
- Chalk to mark court (3 pcs. shipped in pipe)
- Instructions

SOLD SEPARATELY:

- Futpong® ball, visit www.futpong.net to purchase

futpong®

NET ASSEMBLY PARTS:

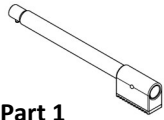

Part 1
Leg (4 pcs.)

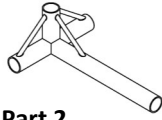

Part 2
Four-way T (2 pcs.)

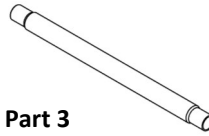

Part 3
Crossbar (1 pc.)

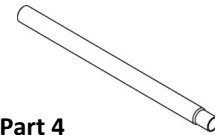

Part 4
Crossbar (3 pcs.)

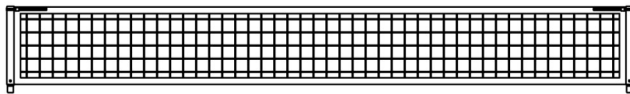

Part 5 Net and Uprights (1 pc.)

ASSEMBLY INSTRUCTIONS:

Step 1: Insert the Legs (Part 1) into the Four-way T (Part 2) by aligning the push button clips with the holes in Four-way T.

Step 2: Insert the Crossbars (Parts 3&4) into the Four-way T.

Step 3: Insert the Net and Uprights (Part 5) into the Four-way T, as shown in Diagram A.

Step 4: Use straps at the net ends and along the bottom to trim net. Do not over tighten.

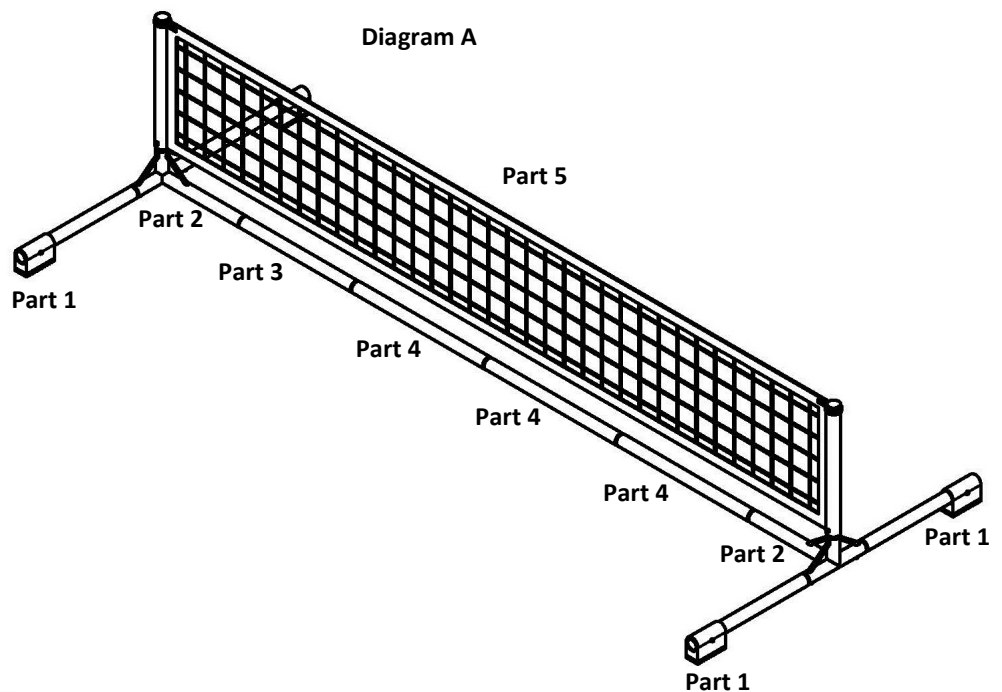
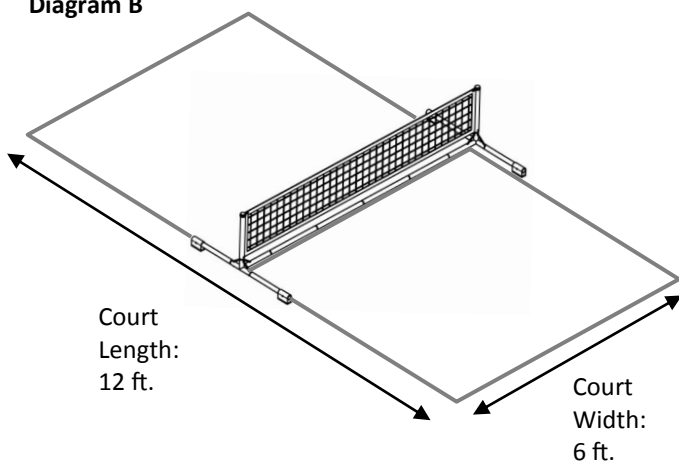

Diagram B



COURT LAYOUT: The court dimensions are 6 ft. wide by 12 ft. long (two adjoining 6x6 ft. squares) as shown in Diagram B. Use the enclosed chalk to create the court. Start by tracing the inside dimensions of both sides of the net and legs at the location you want to use as the centerline. You can then turn the net 90 degrees to one side of the court and trace the sideline, before repeating on the other sideline of the court, and finally using the net to trace the end line. One square is now complete. Repeat on the other square.

Basic Futpong® Game Rules

Futpong® Warnings: Safety is important in all games and we ask that you play Futpong® responsibly. Before beginning play, take extra time to make sure that your playing area is safe, that all players are dressed appropriately and are fit to engage in a strenuous physical activity. Children should be supervised. The choice of whether to play and how to play is yours alone.

1. **Futpong® Equipment, Court Set Up and Storage:**

- Futpong® Equipment: net, carrying bag and chalk, ball sold separately.
- See other side of this page for Futpong® Equipment set-up.
- Your Futpong® Equipment may be damaged if you step, sit or rest any part of your body on your equipment.
- We recommend that your Futpong® Equipment be stored in the carrying bag and not be left out in the weather.

2. **Start of Play:**

- Decide who serves first (rally, coin toss, or other method).
- Serve – Standing at the base line, the server drops or bounces the ball on the ground in the court and then strikes the ball across the net so that the ball bounces somewhere in the opposing player's court. The serve may be played with either foot, or any other body part not including the hands or arms. Server should be standing outside of court.

3. **Return of Serve:**

- The receiving player's goal is to return the serve over the net, so that the ball bounces in the server's court.
- The ball may only bounce once in the receiving player's court before it must be returned.
- The receiving player can return the serve using as many touches as needed, provided the ball does not touch the ground or the player's hands/arms. The ball must not be held by any part of the player's body.
- Expert level: Very skilled players should be limited to one or two touches to return the ball.

4. **Rally:**

- The ball is played back and forth across the net, landing in the court (or played out of the air), until a player is unable to return the ball to the opposing player's court.
- The player who wins the rally serves next.

5. **Scoring:**

- A player only scores when they are serving. Each time a server wins a rally, they are awarded one point.
- The first person who receives 11 points wins, however they must win by at least 2 points. If the players' scores differ by less than 2 points, play continues until there is a two point difference.
- If any part of a player's body touches any part of the net assembly, the opposing player is awarded one point.

Tips and tricks:

- Use different parts of your body when serving. Very young players may use their hands as well as feet to return the ball.
- Pairs Challenge: Each pair plays the ball across the net as many times as possible. The pair with the highest number wins.
- Other variations:
 - Multiple players per side. We've played with as many as 3 players per side.
 - Multiple ball bounces per side.
- Make up your own rules! Just make sure that all players agree and understand them beforehand.

Never forget:

- Play responsibly! Make sure your playing area is safe and that players are fit to engage in strenuous activity.
- Futpong® can be played by almost anyone: soccer and non-soccer players, boys and girls, young people and old, but you should adapt your play to suit the abilities of the players.
- Be a good sport and always play with honesty and a sense of fun. Futpong® is played for enjoyment and to develop soccer skills and get exercise.

We want to hear from you!. Send any comments you have to info@futpong.net or our website at www.futpong.net.